

BOXER-8652AI

AI@Edge Compact Fanless Embedded AI System
with NVIDIA[®] Jetson Orin[™] NX

User's Manual 1st Ed

Copyright Notice

This document is copyrighted, 2025. All rights are reserved. The original manufacturer reserves the right to make improvements to the products described in this manual at any time without notice.

No part of this manual may be reproduced, copied, translated, or transmitted in any form or by any means without the prior written permission of the original manufacturer. Information provided in this manual is intended to be accurate and reliable. However, the original manufacturer assumes no responsibility for its use, or for any infringements upon the rights of third parties that may result from its use.

The material in this document is for product information only and is subject to change without notice. While reasonable efforts have been made in the preparation of this document to assure its accuracy, AAEMON assumes no liabilities resulting from errors or omissions in this document, or from the use of the information contained herein.

AAEMON reserves the right to make changes in the product design without notice to its users.

Acknowledgements

All other products' name or trademarks are properties of their respective owners.

- NVIDIA®, the NVIDIA logo, Jetson™, Jetson Orin™, and JetPack™ are trademarks of the NVIDIA Corporation.
- Arm® and Arm®v8-M architecture are registered trademarks of Arm Limited.
- Linux® is the registered trademark of Linus Torvalds in the U.S. and other countries.
- Ubuntu is a registered trademark of Canonical.

All other product names or trademarks are properties of their respective owners. No ownership is implied or assumed for products, names or trademarks not herein listed by the publisher of this document.

Packing List

Before setting up your product, please make sure the following items have been shipped:

Item	Quantity
● BOXER-8652AI	1
● Wallmount Bracket	2
● Screw Package	1
● Power Connector	1
● Power Adapter (Optional)	1
● Power Cord (Optional)	1

If any of these items are missing or damaged, please contact your distributor or sales representative immediately.

About this Document

This User's Manual contains all the essential information, such as detailed descriptions and explanations on the product's hardware and software features (if any), its specifications, dimensions, jumper/connector settings/definitions, and driver installation instructions (if any), to facilitate users in setting up their product.

Users may refer to the product page at AAEON.com for the latest version of this document.

Safety Precautions

Please read the following safety instructions carefully. It is advised that you keep this manual for future references

1. All cautions and warnings on the device should be noted.
2. All cables and adapters supplied by AAEON are certified and in accordance with the material safety laws and regulations of the country of sale. Do not use any cables or adapters not supplied by AAEON to prevent system malfunction or fires.
3. Make sure the power source matches the power rating of the device.
4. Position the power cord so that people cannot step on it. Do not place anything over the power cord.
5. Always completely disconnect the power before working on the system's hardware.
6. No connections should be made when the system is powered as a sudden rush of power may damage sensitive electronic components.
7. If the device is not to be used for a long time, disconnect it from the power supply to avoid damage by transient over-voltage.
8. Always disconnect this device from any power supply before cleaning.
9. While cleaning, use a damp cloth instead of liquid or spray detergents.
10. Make sure the device is installed near a power outlet and is easily accessible.
11. Keep this device away from humidity.
12. Place the device on a solid surface during installation to prevent falls
13. Do not cover the openings on the device to ensure optimal heat dissipation.
14. Watch out for high temperatures when the system is running.
15. Do not touch the heat sink or heat spreader when the system is running
16. Never pour any liquid into the openings. This could cause fire or electric shock.

17. As most electronic components are sensitive to static electrical charge, be sure to ground yourself to prevent static charge when installing the internal components. Use a grounding wrist strap and contain all electronic components in any static-shielded containers.
18. If any of the following situations arises, please the contact our service personnel:
 - i. Damaged power cord or plug
 - ii. Liquid intrusion to the device
 - iii. Exposure to moisture
 - iv. Device is not working as expected or in a manner as described in this manual
 - v. The device is dropped or damaged
 - vi. Any obvious signs of damage displayed on the device
19. **DO NOT LEAVE THIS DEVICE IN AN UNCONTROLLED ENVIRONMENT WITH TEMPERATURES BEYOND THE DEVICE'S PERMITTED STORAGE TEMPERATURES (SEE CHAPTER 1) TO PREVENT DAMAGE.**

FCC Statement

Warning!



This device complies with Part 15 FCC Rules. Operation is subject to the following two conditions: (1) this device may not cause harmful interference, and (2) this device must accept any interference received including interference that may cause undesired operation.

Caution:

There is a danger of explosion if the battery is incorrectly replaced. Replace only with the same or equivalent type recommended by the manufacturer. Dispose of used batteries according to the manufacturer's instructions and your local government's recycling or disposal directives.

Attention:

Il y a un risque d'explosion si la batterie est remplacée de façon incorrecte. Ne la remplacer qu'avec le même modèle ou équivalent recommandé par le constructeur. Recycler les batteries usées en accord avec les instructions du fabricant et les directives gouvernementales de recyclage.

China RoHS Requirements (CN)

产品中有毒有害物质或元素名称及含量

AAEON System

QQ4-381 Rev.A2

部件名称	有毒有害物质或元素					
	铅 (Pb)	汞 (Hg)	镉 (Cd)	六价铬 (Cr(VI))	多溴联苯 (PBB)	多溴二苯醚 (PBDE)
印刷电路板 及其电子组件	×	○	○	○	○	○
外部信号 连接器及线材	×	○	○	○	○	○
外壳	○	○	○	○	○	○
中央处理器 与内存	×	○	○	○	○	○
硬盘	×	○	○	○	○	○
液晶模块	×	○	○	○	○	○
光驱	×	○	○	○	○	○
触控模块	×	○	○	○	○	○
电源	×	○	○	○	○	○
电池	×	○	○	○	○	○

本表格依据 SJ/T 11364 的规定编制。

○：表示该有毒有害物质在该部件所有均质材料中的含量均在 GB/T 26572 标准规定的限量要求以下。

×：表示该有害物质的某一均质材料超出了 GB/T 26572 的限量要求，然而该部件仍符合欧盟指令 2011/65/EU 的规范。

环保使用期限(EFUP (Environmental Friendly Use Period))：10 年

备注：

- 一、此产品所标示之环保使用期限，系指在一般正常使用状况下。
- 二、上述部件物质中央处理器、内存、硬盘、光驱、电源为选购品。
- 三、上述部件物质液晶模块、触控模块仅一体机产品适用。

China RoHS Requirement (EN)

Name and content of hazardous substances in product

AAEON System

QO4-381 Rev.A2

Part Name	Hazardous Substances					
	铅 (Pb)	汞 (Hg)	镉 (Cd)	六价铬 (Cr(VI))	多溴联苯 (PBB)	多溴二苯醚 (PBDE)
PCB Assemblies	×	○	○	○	○	○
Connector and Cable	×	○	○	○	○	○
Chassis	○	○	○	○	○	○
CPU and Memory	×	○	○	○	○	○
Hard Disk	×	○	○	○	○	○
LCD Modules	×	○	○	○	○	○
CD-ROM/DVD-ROM	×	○	○	○	○	○
Touch Modules	×	○	○	○	○	○
Power	×	○	○	○	○	○
Battery	×	○	○	○	○	○

The table is prepared in accordance with the provisions of SJ/T 11364.

○ : Indicates that said hazardous substance contained in all of the homogenous materials for this product is below the limit requirement of GB/T 26572.

× : Indicates that said hazardous substance contained in at least one of the homogenous materials used for this part is above the limit requirement of GB/T 26572. But this product still be compliance with 2011/65/EU Directive (allowed with 2011/65/EU Annex III of RoHS exemption with number 6(c),7(a),7(c)-1).

EFUP (Environment Friendly Use Period) value: 10 years.

Notes:

1. This product defined period of use is under normal condition.
2. In above part, CPU/Memory/ Hard Disk/CD-ROM/DVD-ROM/ Power are optional.
3. In above part, LCD Modules/ Touch Modules are for all-in-one product model.

Table of Contents

Chapter 1 - Product Specifications	1
1.1 Specifications	2
Chapter 2 – Hardware Information	4
2.1 Dimensions	5
2.2 Jumpers and Connectors.....	6
2.3 List of Jumpers	8
2.3.1 Jumper Settings	8
2.3.2 Auto Power Button (CN3).....	9
2.4 List of Connectors.....	10
2.4.1 RTC Battery Connector (CN1)	12
2.4.2 HDMI Connector (CN5)	12
2.4.3 UART Debug Header (CN27).....	13
2.4.4 Dual USB 3.2 Gen 2 Port (CN16)	13
2.4.5 Dual USB 2.0 Connector (CN17).....	14
2.4.6 4-Pin SoC Fan Header (CN19)	15
2.4.7 NVIDIA Gigabit Ethernet Connector (CN10).....	15
2.4.8 Intel I210-AT Gigabit Ethernet Connector (CN31).....	16
2.4.9 USB 2.0 Pin Header (CN25).....	16
2.4.10 USB 2.0 Pin Header (CN26).....	17
2.4.11 RS-232/422/485 Switch (SW1/SW2).....	17
2.4.12 Front Panel (CN3)	18
2.4.13 M.2 2230 E-Key (CN11).....	19
2.4.14 M.2 2280 M-Key (CN12).....	20
2.4.15 M.2 3042/3052 B-Key (CN13)	21
2.4.16 M.2 3042/3052 B-Key SIM Slot (Nano SIM) (CN14)	22
2.4.17 CANBus Connector (CN9).....	22

2.4.18	15-Pin DIO Connector (CN30).....	23
2.4.19	Micro USB (Flash OS) (CN4).....	25
2.4.20	COM Port 1 (CN7)	25
2.4.21	COM Port 2 Pin Header (CN28).....	26
2.4.22	Power Input Connector (CN32).....	26
2.4.23	System Recovery Button (SW3).....	27
2.4.24	System Power Button (SW5)	27
2.5	Hardware Installation	28
2.5.1	Expansion Module Installation.....	29
2.5.2	Wall Mount Installation.....	30
Chapter 3 – BSP Flash Guide.....		31
3.1	Before Installation.....	32
3.2	Connecting to PC/Force Recovery Mode	33
3.3	Flash Image to Board.....	35
3.4	Check BSP Version.....	36
Chapter 4 – OS User Guide.....		37
4.1	Introduction	38
4.2	Update Note.....	39

Chapter 1

Product Specifications

1.1 Specifications

System

AI Accelerator	NVIDIA® Jetson Orin™ NX
CPU	6-core Arm® Cortex® -A78AE v8.2 64-bit CPU
System Memory	8GB LPDDR5
Storage Device	M.2 2280 M-Key x 1
Display Interface	HDMI 2.0 (Type-A) x 1
Ethernet	RJ-45 x 2 for 10/100/1000 Base-T
I/O	USB 3.2 Gen 2 (Type-A) x 2 USB 2.0 (Type-A) x 2 Micro USB x 1 for OS Flash HDMI 2.0 (Type-A) x 1 DB-9 x 1 for CANbus DB-9 x 1 for RS-232/422/485 DB-15 x 1 for 13-bit DIO Power ON/OFF Switch x 1 Recovery button x 1 Antenna Hole x 6
Expansion	M.2 2230 E-Key x 1 (Wi-Fi/Bluetooth) M.2 3042/3052 B-Key x 1 (4G/5G) M.2 2280 M-Key x 1
Indicator	Power LED x 1
OS Support	Linux (NVIDIA Jetpack™ 5.0 and up)

Power Supply

Power Requirement	DC-in 12-24V with 2-pin Terminal Block
-------------------	--

Mechanical

Mounting	Wall Mount Kit
Dimensions (W x D x H)	5.98" x 3.78" x 2.42" (152mm x 96mm x 61.5mm)
Gross Weight	3.97 lb. (1.8Kg)
Net Weight	2.65 lb. (1.2Kg)

Environmental

Operating Temperature	-5°F ~ 140°F (-15°C ~ 60°C with 0.5 m/s airflow)
Storage Temperature	-40°F ~ 176°F (-40°C ~ 85°C)
Storage Humidity	5 ~ 95% @ 40°C, non-condensing
Anti-Vibration	3.5Grm / 5~500Hz
Anti-Shock	50G peak acceleration
Certification	CE / FCC class A

Chapter 2

Hardware Information

2.1 Dimensions

System

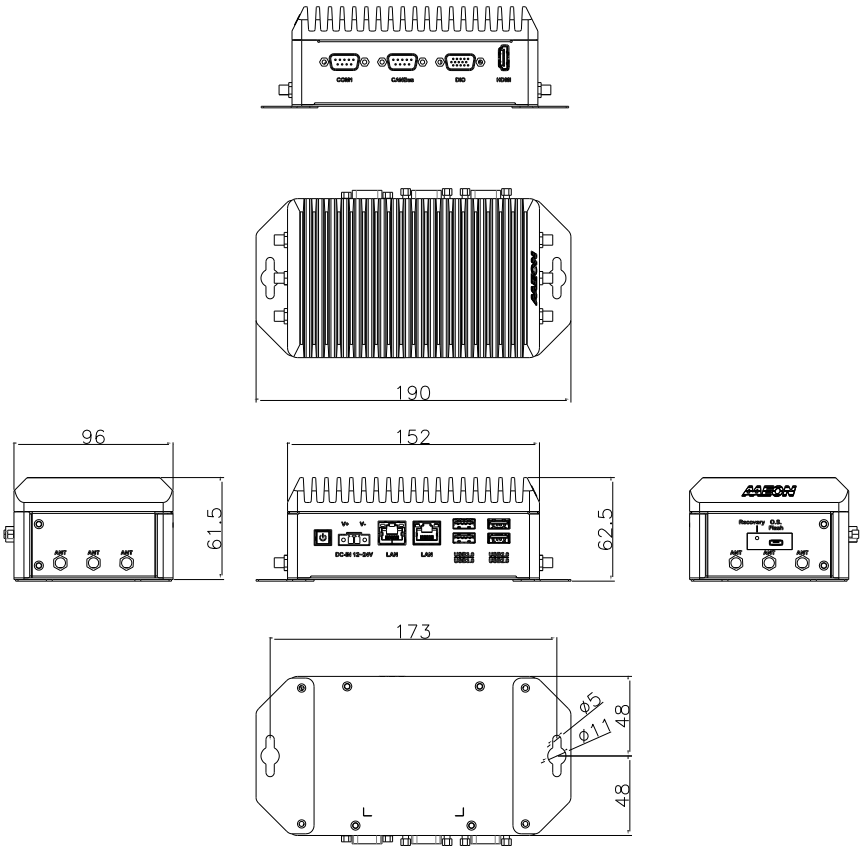

2.2 Jumpers and Connectors

Top

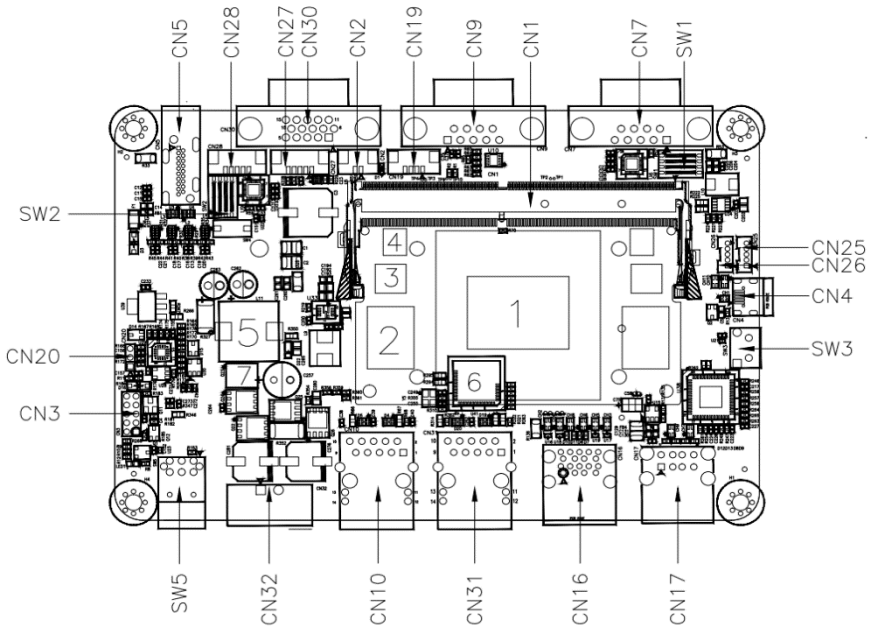

Note: For information regarding how to access the system's PCBA, please see section 2.5.

Bottom

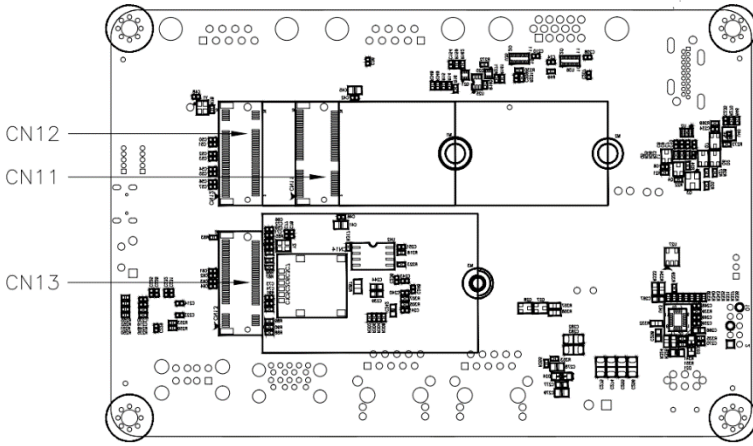

2.3 List of Jumpers

The board has a number of jumpers that allow you to configure your system to suit your application.

The table below shows the function of each of the board's jumpers

Label	Function
CN3 (7-8)	Auto Power Button

2.3.1 Jumper Settings

You configure your card to match the needs of your application by setting jumpers. A jumper is the simplest kind of electric switch. It consists of two metal pins and a small metal clip (often protected by a plastic cover) that slides over the pins to connect them. To "close" a jumper you connect the pins with the clip.

To "open" a jumper you remove the clip. Sometimes a jumper will have three pins, labeled 1, 2 and 3. In this case you would connect either pins 1 and 2 or 2 and 3.

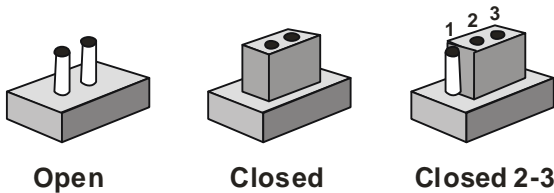

A pair of needle-nose pliers may be helpful when working with jumpers.

If you have any doubts about the best hardware configuration for your application, contact your local distributor or sales representative before you make any change.

Generally, you simply need a standard cable to make most connections.

2.3.2 Auto Power Button (CN3)

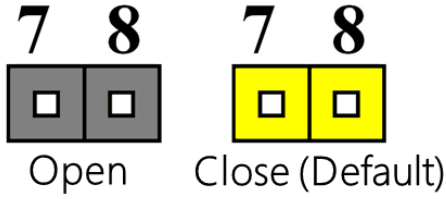

Pin	Function
7-8	Open AT
7-8	Close ATX (Default)

2.4 List of Connectors

The board has a number of connectors that allow you to configure your system to suit your application.

The table below shows the function of each of the board's connectors

Label	Function
CN2	RTC Battery Connector
CN3	Front Panel
CN4	Micro USB (Flash OS)
CN5	HDMI Out
CN27	UART Debug Header
CN7	COM Port 1
SW1	COM 1 RS-232/422/485 Switch
CN28	COM Port 2 Pin Header
SW2	COM 2 RS-232/422/485 Switch
CN9	CANBus
CN10	NVIDIA Gigabit Ethernet Connector
CN11	M.2 2230 E-Key
CN12	M.2 2280 M-Key
CN13	M.2 3042/3052 B-Key
CN31	Intel I210-AT Gigabit Ethernet Connector
CN17	Dual USB 2.0 Connector
CN16	Dual USB 3.2 Gen 2 Port
CN25	USB 2.0 Pin Header
CN26	USB 2.0 Pin Header
SW3	System Recovery Button
SW5	System Power Button
CN19	4-Pin SoC Fan Header

Label	Function
CN32	Power Input Connector
CN30	15-Pin DIO Connector
CN14	M.2 3042/3052 B-Key SIM Slot (Nano SIM)

2.4.1 RTC Battery Connector (CN1)

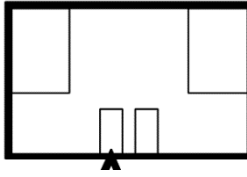

Pin	Signal	Pin	Signal
1	+3V	2	GND

2.4.2 HDMI Connector (CN5)

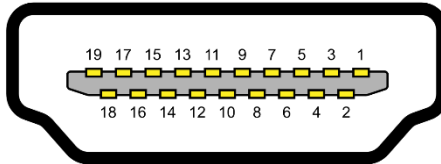

Pin	Signal	Pin	Signal
1	HDMI_DATA2_P	2	GND
3	HDMI_DATA2_N	4	HDMI_DATA1_P
5	GND	6	HDMI_DATA1_N
7	HDMI_DATA0_P	8	GND
9	HDMI_DATA0_N	10	HDMI_CLK_P
11	GND	12	HDMI_CLK_N
13	NC	14	NC
15	HDMI_SCL	16	HDMI_SDA
17	GND	18	HDMI_PWR
19	HDMI_HDP		

2.4.3 UART Debug Header (CN27)

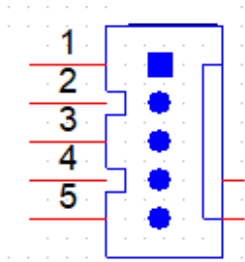

Pin	Signal	Pin	Signal
1	3.3V	2	UART0_TXD_HDR
3	UART0_RXD_HDR	4	GND
5	GND		

2.4.4 Dual USB 3.2 Gen 2 Port (CN16)

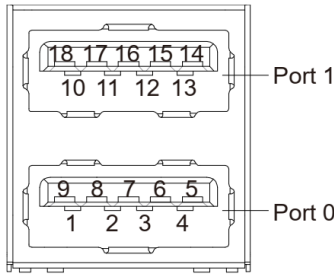

Pin	Signal	Pin	Signal
U1	VBUS_1	U10	VBUS_2
U2	(A)D-	U11	(B)D-
U3	(A)D+	U12	(B)D+
U4	GND	U13	GND

Pin	Signal	Pin	Signal
U5	(A)SSRX-	U14	(B)SSRX-
U6	(A)SSRX+	U15	(B)SSRX+
U7	GND	U16	GND
U8	(A)SSTX-	U17	(B)SSTX-
U9	(A)SSTX+	U18	(B)SSTX+

2.4.5 Dual USB 2.0 Connector (CN17)

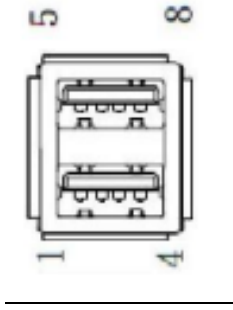

Pin	Signal	Pin	Signal
1	VCC 5V	2	USB D-
3	USB D+	4	GND
5	VCC 5V	6	USB D-
7	USB D+	8	GND

2.4.6 4-Pin SoC Fan Header (CN19)

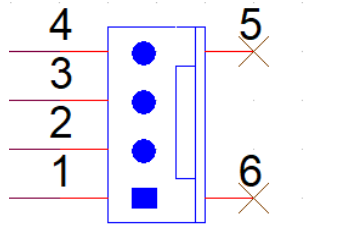

Pin	Signal	Pin	Signal
1	GND	2	VDD_5V
3	FAN_TACH	4	FAN_PWM

2.4.7 NVIDIA Gigabit Ethernet Connector (CN10)

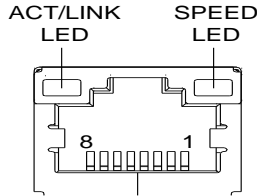

Pin	Signal	Pin	Signal
1	MDI0+	2	MDI0-
3	MDI1+	4	MDI1-
5	MDI2+	6	MDI2-
7	MDI3+	8	MDI3-

2.4.8 Intel I210-AT Gigabit Ethernet Connector (CN31)

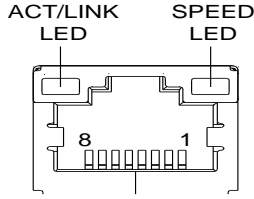

Pin	Signal	Pin	Signal
1	MDI0+	2	MDI0-
3	MDI1+	4	MDI1-
5	MDI2+	6	MDI2-
7	MDI3+	8	MDI3-

2.4.9 USB 2.0 Pin Header (CN25)

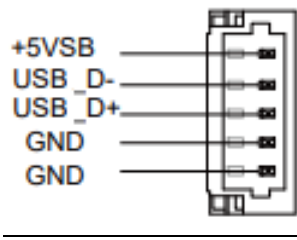

Pin	Signal	Pin	Signal
1	VDD_5V_IN	2	USB_D-
3	USB_D+	4	GND
5	GND		

2.4.10 USB 2.0 Pin Header (CN26)

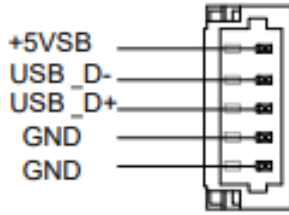

Pin	Signal	Pin	Signal
1	VDD_5V_IN	2	USB_D-
3	USB_D+	4	GND
5	GND		

2.4.11 RS-232/422/485 Switch (SW1/SW2)

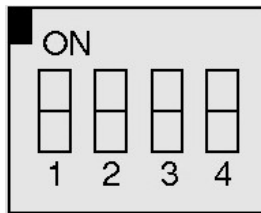

Mode	S-1	S-2	S-3	S-4
1T/1R RS-232	On	On		
1T/1R RS-422	On	Off		
1T/1R RS-485	Off	On		
Low Power Shutdown	Off	Off		
250kbps for RS-232 and RS-485/ 422				On
RS-232 to 3Mbps and RS-485/ 422 to 20Mbps				Off

Mode	S-1	S-2	S-3	S-4
Enable RS-422/ 485 Bias and Termination Resistors.			On	
Disable RS-422/485 Bias and Termination Resistors.			Off	

2.4.12 Front Panel (CN3)

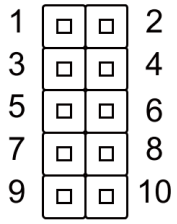

Pin	Signal	Pin	Signal
1	PWR_BTN*	2	GND
3	FORCE_RECOVERY	4	GND
5	SYS_RST*	6	GND
7	BMCU_ACOK	8	GND
9	3V3	10	VDD_5V_IN

2.4.13 M.2 2230 E-Key (CN11)

		GND	75
74	3.3V	RESERVED/REFCLKn1	73
72	3.3V	RESERVED/REFCLKp1	71
70	UIM_POWER_SRC/GPIO1/PEWAKE1#	GND	69
68	UIM_POWER_SNK/CLKREQ1#	RESERVED/PETn1	67
66	UIM_SWP/PERST1#	RESERVED/PETp1	65
64	RESERVED	GND	63
62	ALERT# (O)(0/3.3V)	RESERVED/PERn1	61
60	I2C_CLK (I)(0/3.3V)	RESERVED/PERp1	59
58	I2C_DATA (I/O)(0/3.3V)	GND	57
56	W_DISABLE1# (I)(0/3.3V)	PEWAKE0# (I/O)(0/3.3V)	55
54	W_DISABLE2# (I)(0/3.3V)	CLKREQ0# (I/O)(0/3.3V)	53
52	PERST0# (I)(0/3.3V)	GND	51
50	SUSCLK(32kHz) (I)(0/3.3V)	REFCLKn0	49
48	COEX1 (I/O)(0/1.8V)	REFCLKp0	47
46	COEX2(I/O)(0/1.8V)	GND	45
44	COEX3(I/O)(0/1.8V)	PETn0	43
42	VENDOR DEFINED	PETp0	41
40	VENDOR DEFINED	GND	39
38	VENDOR DEFINED	PERn0	37
36	UART CTS (I)(0/1.8V)	PERp0	35
34	UART RTS (O)(0/1.8V)	GND	33
32	UART RXD (I)(0/1.8V)	Module Key	
	Module Key	Module Key	
	Module Key	Module Key	
	Module Key	Module Key	
22	UART TXD (O)(0/1.8V)	SDIO RESET# (I)(0/1.8V)	23
20	UART WAKE# (O)(0/3.3V)	SDIO WAKE# (O)(0/1.8V)	21
18	GND	SDIO DATA3(I/O)(0/1.8V)	19
16	LED2# (O)(OD)	SDIO DATA2(I/O)(0/1.8V)	17
14	PCM_IN/I2S SD_IN (I)(0/1.8V)	SDIO DATA1(I/O)(0/1.8V)	15
12	PCM_OUT/I2S SD_OUT (O)(0/1.8V)	SDIO DATA0(I/O)(0/1.8V)	13
10	PCM_SYNC/I2S WS (I/O)(0/1.8V)	SDIO CMD(I/O)(0/1.8V)	11
8	PCM_CLK/I2S SCK (I/O)(0/1.8V)	SDIO CLK(I)(0/1.8V)	9
6	LED1# (O)(OD)	GND	7
4	3.3V	USB_D-	5
2	3.3V	USB_D+	3
		GND	1

2.4.14 M.2 2280 M-Key (CN12)

74	3.3V	GND	75
72	3.3V	GND	73
70	3.3V	GND	71
68	SUSCLK(32kHz) (O)(0/3.3V)	PEDET (NC-PCIe/GND-SATA)	69
	Connector Key	N/C	67
	Connector Key	Connector Key	
	Connector Key	Connector Key	
	Connector Key	Connector Key	
38	N/C	GND	37
36	N/C	REFCLKp	35
34	PEWAKE# (I/O)(0/3.3V) or N/C	REFCLKn	33
32	CLKREQ# (I/O)(0/3.3V) or N/C	GND	31
30	PERST# (O)(0/3.3V) or N/C	PETp0/SATA-A+	49
48	N/C	PETn0/SATA-A-	47
46	N/C	GND	45
44	N/C	PERp0/SATA-B-	43
42	N/C	PERn0/SATA-B+	41
40	N/C	GND	39
38	DEVSLP (O)	PETp1	37
36	N/C	PETn1	35
34	N/C	GND	33
32	N/C	PERp1	31
30	N/C	PERn1	29
28	N/C	GND	27
26	N/C	PETp2	25
24	N/C	PETn2	23
22	N/C	GND	21
20	N/C	PERp2	19
18	3.3V	PERn2	17
16	3.3V	GND	15
14	3.3V	PETp3	13
12	3.3V	PETn3	11
10	DAS/DSS# (I/O)/LED1# (I)(0/3.3V)	GND	9
8	N/C	PERp3	7
6	N/C	PERn3	5
4	3.3V	GND	3
2	3.3V	GND	1

2.4.15 M.2 3042/3052 B-Key (CN13)

74	3.3V	GND	75
72	3.3V	RESERVED/REFCLKN1	73
70	UIM_Power_In/GPIO1/PEWake1#	RESERVED/REFCLKP1	71
68	UIM_Power_Out/CLKREQ1#	GND	69
66	UIM_SWP/PERST1#	Reserved/PERn1	67
64	RESERVED	Reserved/PERp1	65
62	ALERT# (I)(0/3.3)	GND	63
60	I2C CLK (O)(0/3.3)	Reserved/PETn1	61
58	I2C DATA (IO)(0/3.3)	Reserved/PETp1	59
56	W_DISABLE#1 (O)(0/3.3V)	GND	57
54	Reserved/W_DISABLE#2 (O)(0/3.3V)	PEWake0# (IO)(0/3.3V)	55
52	PERST0# (O)(0/3.3V)	CLKREQ0# (IO)(0/3.3V)	53
50	SUSCLK(32kHz) (O)(0/3.3V)	GND	51
48	COEX1 (I/O)(0/1.8V)	REFCLKN0	49
46	COEX2 (I/O)(0/1.8V)	REFCLKP0	47
44	COEX3 (I/O)(0/1.8V)	GND	45
42	VENDOR DEFINED	PERn0	43
40	VENDOR DEFINED	PERp0	41
38	VENDOR DEFINED	GND	39
36	UART RTS (O)(0/1.8V)	PETn0	37
34	UART CTS (I)(0/1.8V)	PETp0	35
32	UART Tx (O)(0/1.8V)	GND	33
	Connector Key	Connector Key	
	Connector Key	Connector Key	
	Connector Key	Connector Key	
	Connector Key	Connector Key	
22	UART Rx (I)(0/1.8V)	SDIO Reset(O)(0/1.8V)	23
20	UART Wake (I)(0/3.3V)	SDIO Wake(I)(0/1.8V)	21
18	GND	SDIO DAT3(IO)(0/1.8V)	19
16	LED#2 (I)(OD)	SDIO DAT2(IO)(0/1.8V)	17
14	PCM_OUT/I2S SD_OUT (O)(0/1.8V)	SDIO DAT1(IO)(0/1.8V)	15
12	PCM_IN/I2S SD_IN (I)(0/1.8V)	SDIO DAT0(IO)(0/1.8V)	13
10	PCM_SYNC/I2S WS (O)(0/1.8V)	SDIO CMD(IO)(0/1.8V)	11
8	PCM_CLK/I2S SCK (O)(0/1.8V)	SDIO CLK(O)(0/1.8V)	9
6	LED#1 (I)(OD)	GND	7
4	3.3V	USB_D-	5
2	3.3V	USB_D+	3
		GND	1

2.4.16 M.2 3042/3052 B-Key SIM Slot (Nano SIM) (CN14)

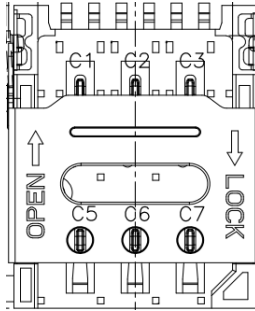

Pin	Signal	Pin	Signal
C1	VCC	C2	RST
C3	CLK	C5	GND
C6	NA	C7	DATA

2.4.17 CANBus Connector (CN9)

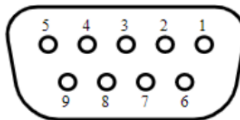

Pin	Function	Voltage Level
1	NA	
2	CAN0_L	
3	GND	
4	NA	
5	GND	
6	NA	
7	CAN0_H	

Pin	Function	Voltage Level
8	NA	
9	VDD_5V_IN	

2.4.18 15-Pin DIO Connector (CN30)

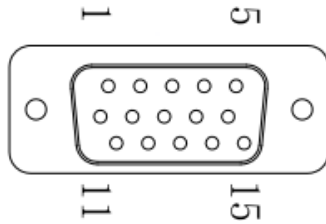

Pin	Function	Voltage Level	GPIO ID
1	VDD_3.3V	3.3V-	NA
2	SPI1_MOSI_LS	3.3V-	PY.02
3	SPI1_MISO_LS	3.3V-	PY.01
4	SPI1_SCK_LS	3.3V-	PY.00
5	SPI1_CS0_LS	3.3V-	PY.03
6	SPI0_MOSI_LS	3.3V-	PZ.05
7	SPI0_MISO_LS	3.3V-	PZ.04
8	SPI0_SCK_LS	3.3V-	PZ.03
9	SPI0_CS0_LS	3.3V-	PZ.06
10	SPI0_CS1_LS	3.3V-	PZ.07
11	I2S0_LRCK_LS	3.3V-	PI.02
12	I2S0_SDIN_LS	3.3V-	PI.01
13	I2S0_SDOOUT_LS	3.3V-	PI.00
14	I2S0_SCLK_LS	3.3V-	PH.07
15	GND	GND	NA

Export GPIO then you can use control GPIO from user space through sysfs.

Demonstration:

Take "GPIO ID : PY.02" as an example

Export PY.02

```
# echo PY.02 > /sys/class/gpio/export
```

1. Set GPIO direction to output mode

```
# echo "out" > /sys/class/gpio/PY.02/direction
```

```
# echo 1 > /sys/class/gpio/PY.02/value    #Set the output value is 1
```

```
# echo 0 > /sys/class/gpio/PY.02/value    #Set the output value is 0
```

2. Set GPIO direction to input mode

```
# echo "in" > /sys/class/gpio/PY.02/direction
```

```
# cat /sys/class/gpio/PY.02/value        #Read the input value of GPIO
```

Unexport PY.02

```
# echo PY.02 > /sys/class/gpio/unexport
```

2.4.19 Micro USB (Flash OS) (CN4)

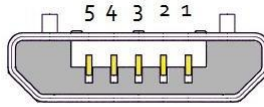

USB Micro-B

Pin	Signal	Pin	Signal
1	+5V	2	USB1-
3	USB1+	4	NA
5	GND		

2.4.20 COM Port 1 (CN7)

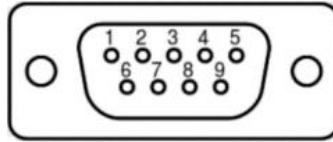

Pin	RS-232	RS-422	RS-485
1		TX-	D-
2	RXD	TX+	D+
3	TXD	RX+	
4		RX-	
5	GND		
6			
7			
8			
9			

2.4.21 COM Port 2 Pin Header (CN28)

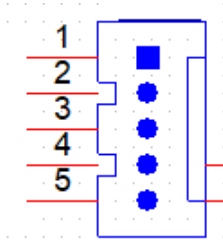

Pin	RS-232	RS-422	RS-485
1		TX-	D-
2	RXD	TX+	D+
3	TXD	RX+	
4		RX-	
5	GND		

2.4.22 Power Input Connector (CN32)

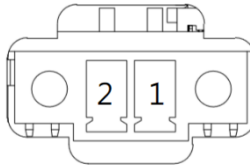

Pin	Signal	Pin	Signal
1	+12V	2	GND

2.4.23 System Recovery Button (SW3)

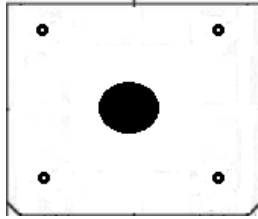

Pin	Signal	Pin	Signal
1	GND	2	GND
3	FORCE_RECOVERY*	4	GND

2.4.24 System Power Button (SW5)

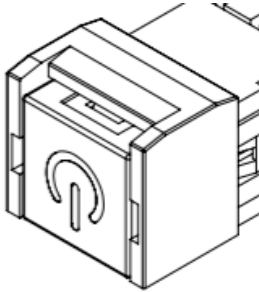

Pin	Signal	Pin	Signal
1	NA	2	GND
3	PWR_BTN	4	NA GND
5	GND	6	PWR_BTN
L1	VDD_5V	L2	PWR_LED

2.5 Hardware Installation

Chassis Components

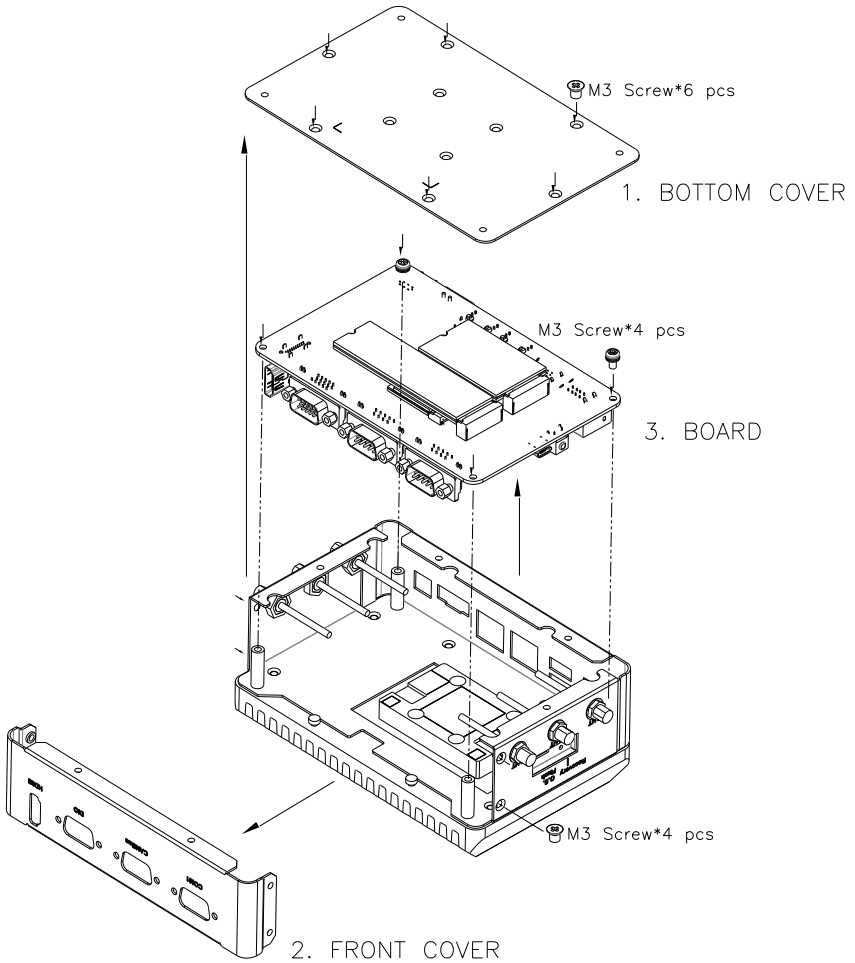

Note: Before installing expansion modules, ensure the system is powered down and disconnect the power cord from the system.

2.5.1 Expansion Module Installation

Turn the BOXER-8652AI system over so the bottom is facing up. Install each module by first inserting at an angle (approx. 30°), then gently press down to secure. Refer to the images below for guidance on removing the bottom panel and location of each M.2 Key slot.

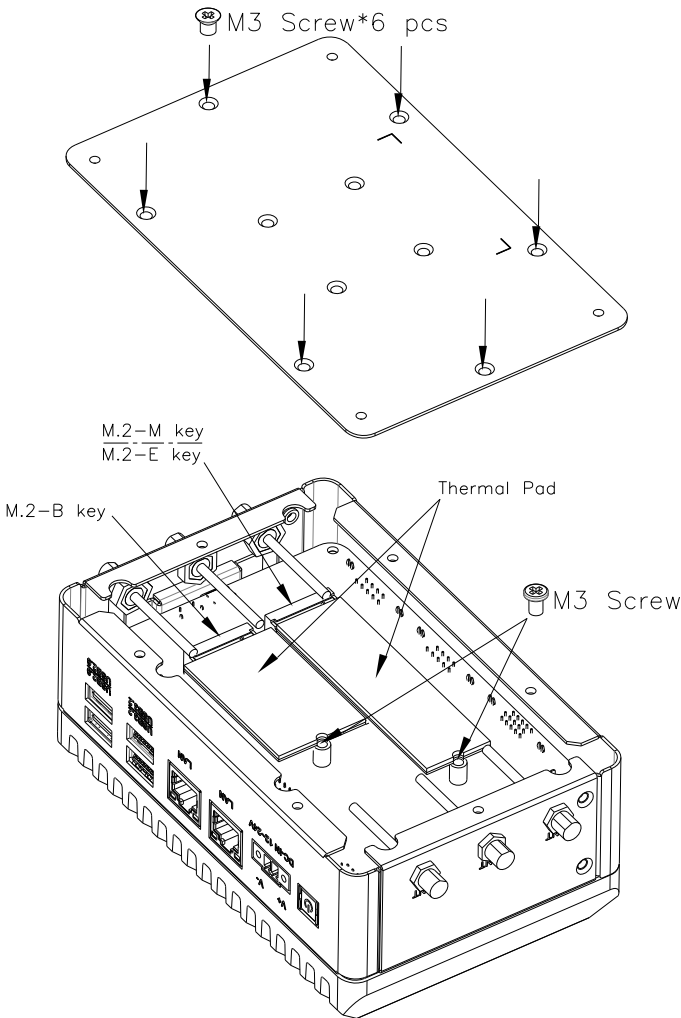

2.5.2 Wall Mount Installation

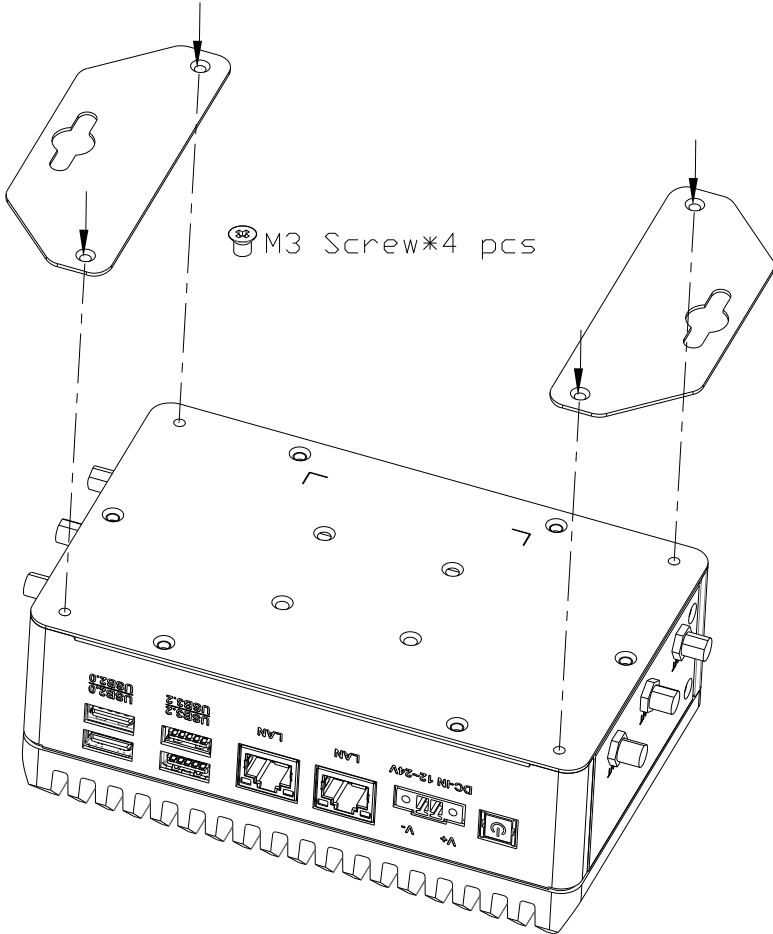

Chapter 3

BSP Flash Guide

3.1 Before Installation

Before starting the process make sure your BOXER-8652AI system is turned off and the power is disconnected. You will need a Host PC running Ubuntu 18.04/20.04, and make sure the NVIDIA Jetson Orin NX module is installed onto the BOXER-8652AI carrier board system.

Note: Do not use a virtual machine as a host PC, as some virtual machines may have unstable USB connections which can cause the flash procedure to fail.



Download the compressed BSP image file

“[BOXER-8652AI_J5.1.1_A00_1.0.0_20230508.tar.gz](#)” into the Host Ubuntu 18.04/20.04 PC directory.

Note: No spaces, special characters, or non-English characters can be used for the name of the folder where the file is stored, or its parent folder.

Note: Ensure the language settings of Ubuntu 18.04/20.04 are set to English, and the format setting is the United States, to prevent flash failure.

Note: Ensure you have more than 160GB storage available on the HD.

3.2 Connecting to PC/Force Recovery Mode

Step 1:

On the Host computer, open Linux terminal and enter the following command to extract the compressed BSP image files (BSP file name may vary):

```
$ sudo tar -zxvf
BOXER_8652AI_J5.1.1_A00_1.0.0_20230508.tar.gz
```

Note: Do not decompress the file (i.e. FAT NTFS exFAT) using a Windows OS, BSP should only be decompressed in a Linux EXT3/4 file system.

Step 2:

Perform the following actions to force the system to start in USB Recovery Mode:

1. Connect the Micro-USB plug on the USB cable to the Recovery Port on the BOXER-8652AI, and the other end to an available USB port on the Host PC.
2. Connect the BOXER-8652AI to a power supply.
3. Press and hold the recovery key button. While holding the recovery key button, power on the system, and continue to hold the recovery key button for two seconds, then release. The BOXER-8652AI should then enter recovery mode.
4. To check if device is in recovery mode, enter the command `lsusb` in terminal on Host.

```
$ lsusb | grep "0955:7323"
```

If successful, the command will return `"0955:7323 Nvidia Corp"`

```
Bus 001 Device 038: ID 0955:7323 NVidia Corp.
```

Note: Recovery mode cannot be initiated if the NVIDIA Jetson Orin NX module is disassembled. Ensure the NVIDIA Jetson Orin NX module is installed and refer to the image below to perform the force recovery mode steps:

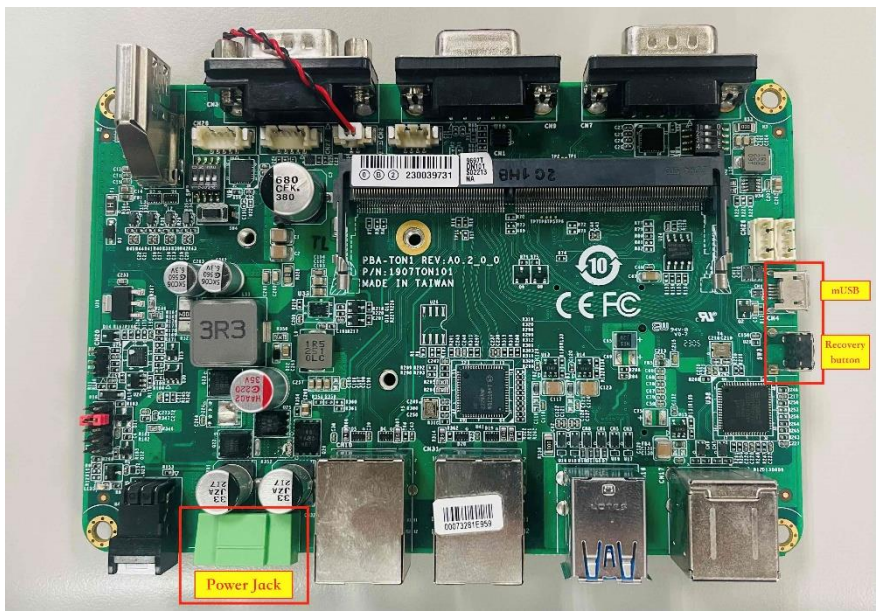

3.3 Flash Image to Board

Use the following steps to flash the OS to the BOXER-8652AI.

1) Open terminal on the Ubuntu Host PC, then access the folder you extracted in the previous section.

2) Enter the following command in terminal to flash the image:

```
$ ./flashboxer.sh -s 62517420 nvme
```

3) Wait as the image is installed. Once complete you should see the following:

```
writing item=16, 9:0:secondary_gpt, 32008902144, 16896, gpt_secondary_9_0.bin, 16896, fixed-<reserved>-0, 59012273e727e6a457084ff7805a26ed6cf1c4fa
[ 309]: l4t_flash_from_kernel: Successfully flash the external device
[ 309]: l4t_flash_from_kernel: Flashing success
[ 309]: l4t_flash_from_kernel: The device size indicated in the partition layout xnl is smaller than the actual size. This utility will try to fix the GPT.
Flash is successful
Reboot device
Cleaning up...
```

4) After Steps 2 and 3, mass-flash image is built up internally, so you can flash up to 10 targets at once by using the following command:

```
$ ./flashboxer.sh -m nvme
```

3.4 Check BSP Version

Once the flash image is successfully installed, the BOXER-8652AI will reboot automatically, then check the BSP version to see if the system is flashing the correct version of BSP.

Open a Terminal, and type command `“cat /proc/product”`

You will see the product name with version and date

```
BOXER-8652AI_J5.1.1_A00_1.0.0_20230508
```

The version name will follow the format of:

```
{PJ_IF}_{JPV_IF}_A00_{IMGV_IF}_{BD_IF}
```

For example:

```
BOXER-8652AI_J5.1.1_A00_1.0.0_20230508
```

Note: Filename may differ from this example.

{PJ_IF} is Project Information; e.g. BOXER-8652AI

{JPV_IF} is Nvidia Jetpack Version; e.g. J5.1.1

{IMGV_IF} is Aaeon BSP Version; e.g. 1.0.0

{BD_IF} is BSP Build Date; e.g. 20230508

Chapter 4

OS User Guide

4.1 Introduction

The BOXER-8652AI's OS, Ubuntu/Linux version, and preinstalled SDK components are as follows:

For **Jetpack 5.1.1 (L4t 35.3.1)**

1. Ubuntu/Linux version
 - a. Ubuntu version: 20.04.6
 - b. Kernel version: 5.10.104-tegra
 - c. UEFI version: 3.1-32827747
2. Built-in all Jetson SDK Components
 - a. CUDA Toolkit for L4T 11.4.19
 - b. cuDNN 8.6.0
 - c. TensorRT 8.5.2
 - d. OpenCV 4.5.4
 - e. VPI 2.2
 - f. NVIDIA Container Runtime 1.11
 - g. Multimedia API 35.3
 - h. Deepstream 6.2
3. Built-in Allxon DMS
 - a. Please refer to vendor website at <https://www.allxon.com/solutions>

Default login user/password is:

Account: **aaeon**

Password: **aaeon**

4.2 Update Note

Running `$ sudo apt upgrade` command in terminal will overwrite the **Aaeon kernel device tree(.dtb)/kernel image(Image)/bootloader** in the OS, which can lead to unexpected results, including the loss of I/O ports.

So Aaeon default disable Nvidia apt Repo for updating Nvidia apt package.

AAEON maintains updated versions of BSP on the product page, which follow updates to the NVIDIA Jetpack software. Contact your AAEON representative or visit the product page to download the latest version of Aaeon BSP for your system:

<https://www.aaeon.com/en/>